

















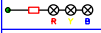



**PROJECT: ELECTRICAL DESIGN OF CAMP-1E NFI
DISTRIBUTION POINT**

Location: Camp-1E, Ukhiya, Cox's Bazar.

Date of Submission: December 04, 2025

Drawing Title: ELECTRICAL DRAWING

LEGEND		
SYMBOL	ABBREVIATION	DESCRIPTION
	TL	TUBE LIGHT 20 W (1200mm)
	CF	CEILING FAN (56")
	WL	WALL LIGHT (24 W) (LED BULB)
	AC	AC INDOOR UNIT (SPLIT TYPE)
	SB	SWITCH BOARD (H:48")
	CL	12W CEILING LIGHT (ROUND)
	QS	13 A 6 PIN COMBINE SOCKET (18" FROM FINISHED FLOOR)
	QM	20 A SOCKET (LINTEL LEVEL)
	CB	CIRCUIT BREAKER
		PHASE INDICATOR
	SDB	SUB DISTRIBUTION BOARD
	MDB	MAIN DISTRIBUTION BOARD
	SMDB	SUB MAIN DISTRIBUTION BOARD
	WMF	WALL MOUNTED FAN
	EX	EXHAUST FAN (12")
	FL	FLOOD LIGHT 50 W
	PL	PANEL LIGHT 24 W (300mmX300mm)
		LIGHTING CONDUIT
		POWER CONDUIT
		SWITCH CONDUIT
	CF	CEILING FAN 36"

CLIENT: UNHCR	PROJECT NAME: ELECTRICAL DESIGN OF CAMP-1E NFDISTRIBUTION POINT	PARTICULARS:	NAME:	SIGNATURE:	DRAWING TITLE: LEGEND	REVISION NO. DATE & TIME DESCRIPTION	CONSULTANT:	NOTES: THIS DRAWINGS SHALL BE READ IN CONJUNCTION WITH RELEVANT ARCHITECTURAL, PLUMBING, ELECTRICAL AND MECHANICAL DRAWINGS	COPYRIGHT:	REMARKS:	SHEET NO: E-01
PROJECT ADDRESS: Camp-1E, UKHIYA, COX'S BAZAR	SCALE: NOT IN SCALE				DATE: 04-DEC-2025	01. - - 02. - - 03. - - 04. - - 05. - -					

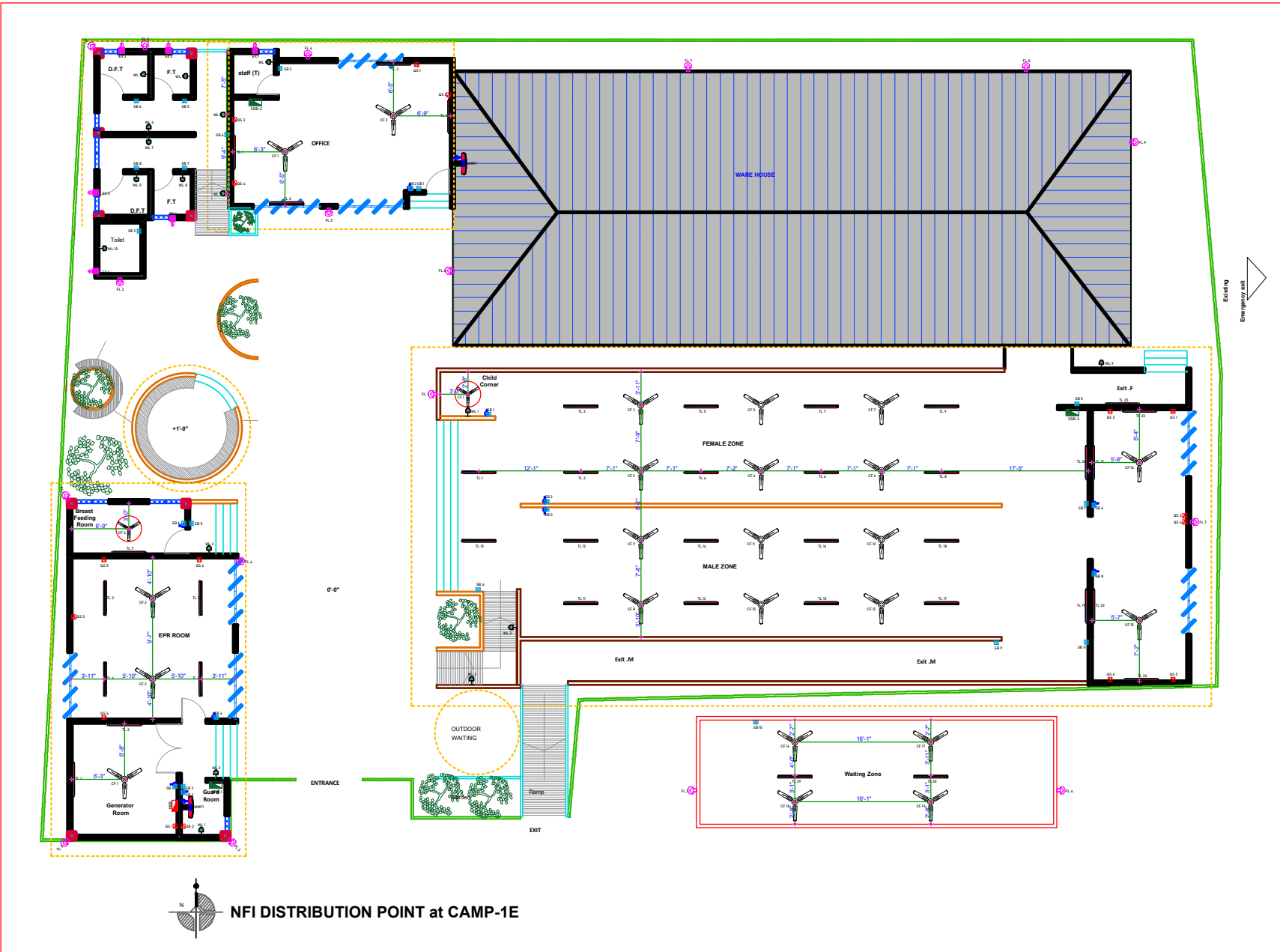

NFI DISTRIBUTION POINT at CAMP-1E

CLIENT: UNHCR	PROJECT NAME: ELECTRICAL DESIGN OF CAMP-1E NFI DISTRIBUTION POINT	PARTICULARS:	NAME:	SIGNATURE:	DRAWING TITLE: ELECTRICAL LAYOUT PLAN	REVISION:	CONSULTANT:	NOTES: THIS DRAWINGS SHALL BE READ IN CONJUNCTION WITH RELEVANT ARCHITECTURAL, PLUMBING, ELECTRICAL AND MECHANICAL DRAWINGS	COPYRIGHT:	REMARKS:	SHEET NO: E-02
PROJECT ADDRESS: Camp-1E, UKHIYA, COX'S BAZAR	SCALE: NOT IN SCALE				DATE: 04-DEC-2025	NO. DATE & TIME: DESCRIPTION					
						01. - -					
						02. - -					
						03. - -					
						04. - -					
						05. - -					

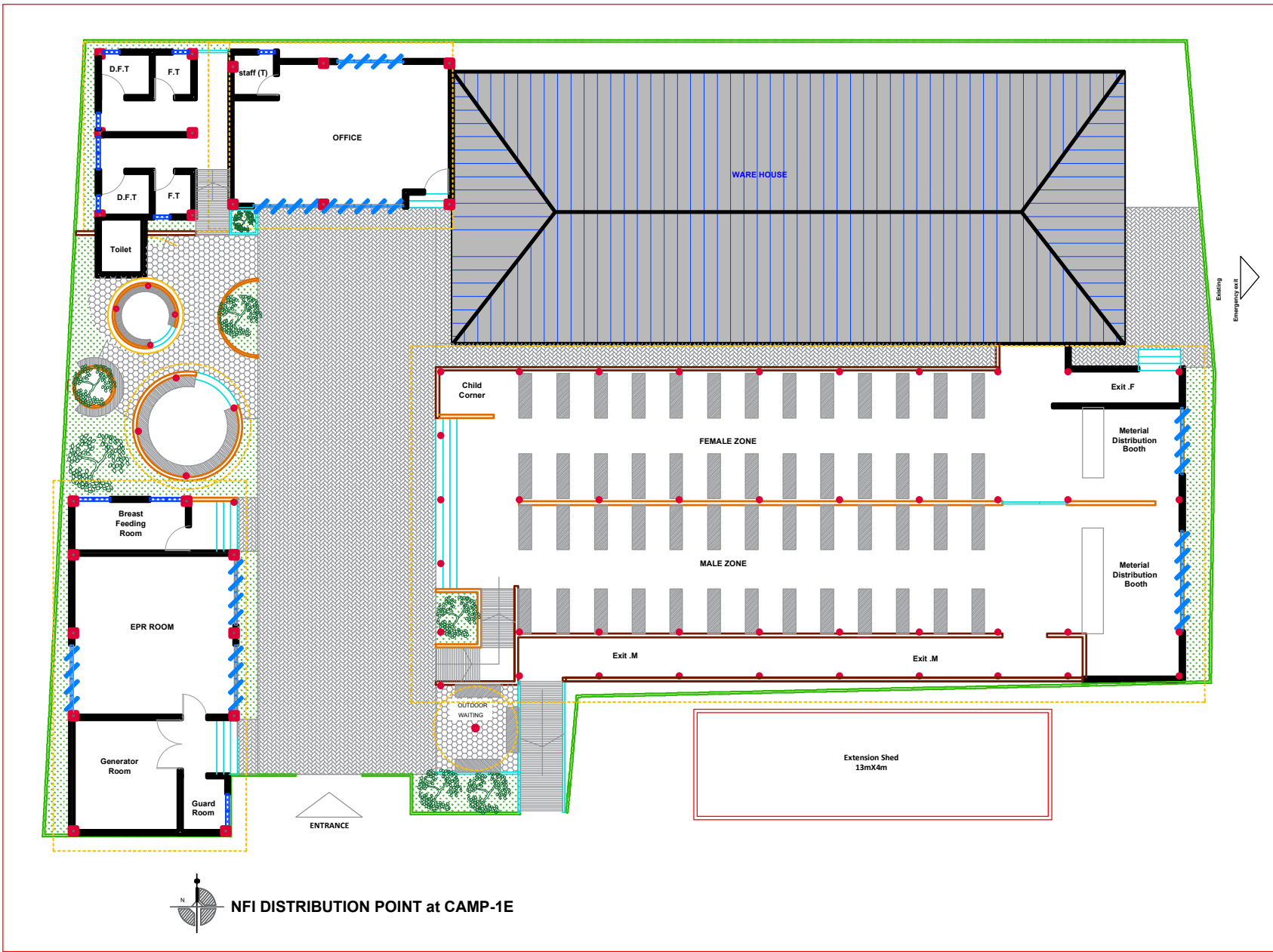

NFI DISTRIBUTION POINT at CAMP-1E

CLIENT: UNHCR	PROJECT NAME: ELECTRICAL DESIGN OF CAMP-1E NFI DISTRIBUTION POINT	PARTICULARS:	NAME:	SIGNATURE:	DRAWING TITLE: FLOOR PLAN	REVISION NO. DATE & TIME DESCRIPTION	CONSULTANT:	-NOTES- THIS DRAWINGS SHALL BE READ IN CONJUNCTION WITH RELEVANT ARCHITECTURAL, PLUMBING, ELECTRICAL AND MECHANICAL DRAWINGS	-COPYRIGHT-	REMARKS	SHEET NO: E-03
PROJECT ADDRESS: Camp-1E, UKHIYA, COX'S BAZAR	SCALE: NOT IN SCALE				DATE: 04-DEC-2025	01. - - 02. - - 03. - - 04. - - 05. - -					

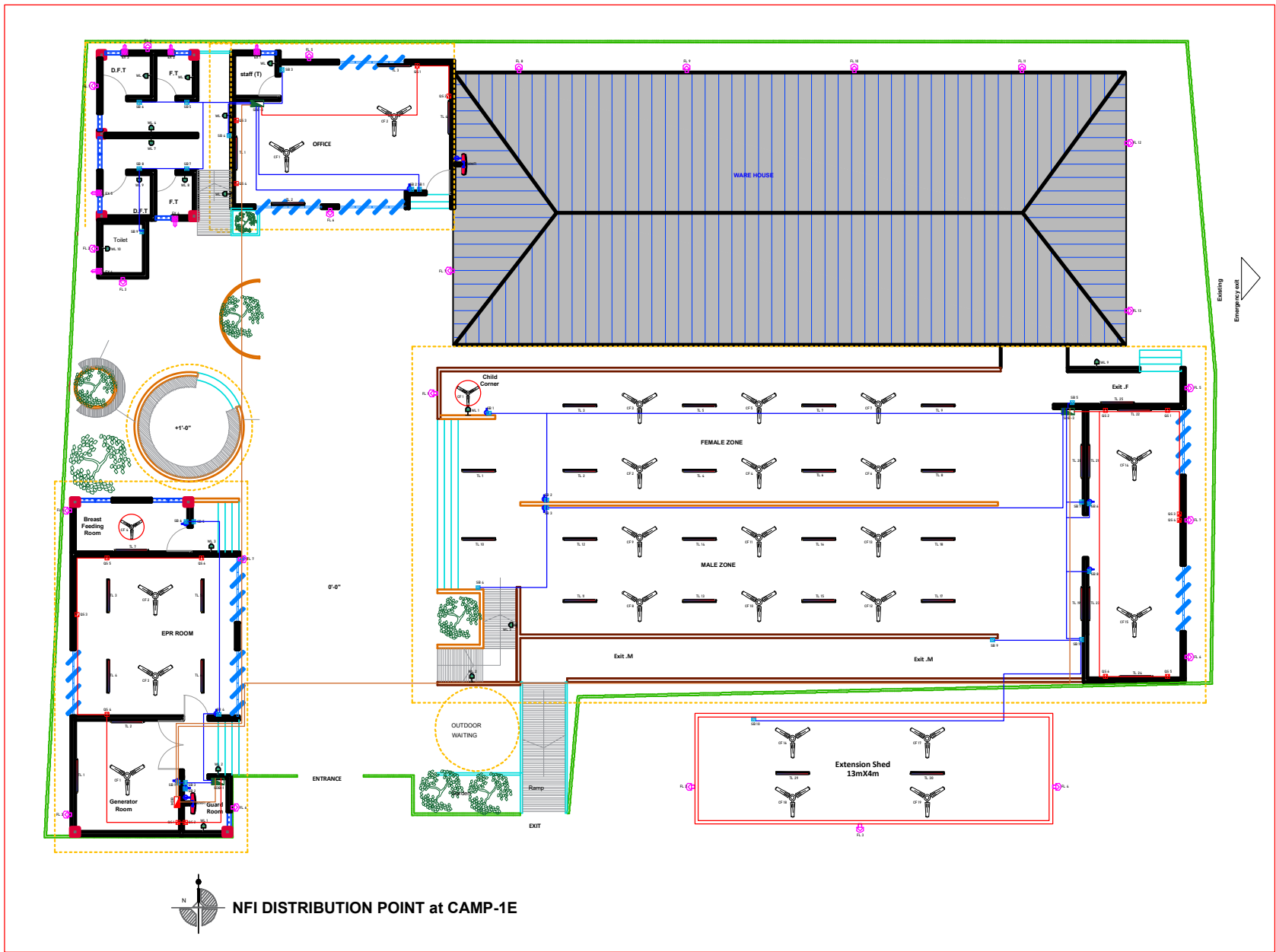

NFI DISTRIBUTION POINT at CAMP-1E

CLIENT: UNHCR	PROJECT NAME: ELECTRICAL DESIGN OF CAMP-1E NFI DISTRIBUTION POINT	PARTICULARS:	NAME:	SIGNATURE:	DRAWING TITLE: POWER CONDUIT PLAN	REVISION:	CONSULTANT:	-NOTES- THIS DRAWINGS SHALL BE READ IN CONJUNCTION WITH RELEVANT ARCHITECTURAL, PLUMBING, ELECTRICAL AND MECHANICAL DRAWINGS	-COPYRIGHT-	REMARKS	SHEET NO: E-04
PROJECT ADDRESS: Camp-1E, UKHIYA, COX'S BAZAR	SCALE: NOT IN SCALE				DATE: 04-DEC-2025	NO. DATE & TIME DESCRIPTION 01. - - - 02. - - - 03. - - - 04. - - - 05. - - -					

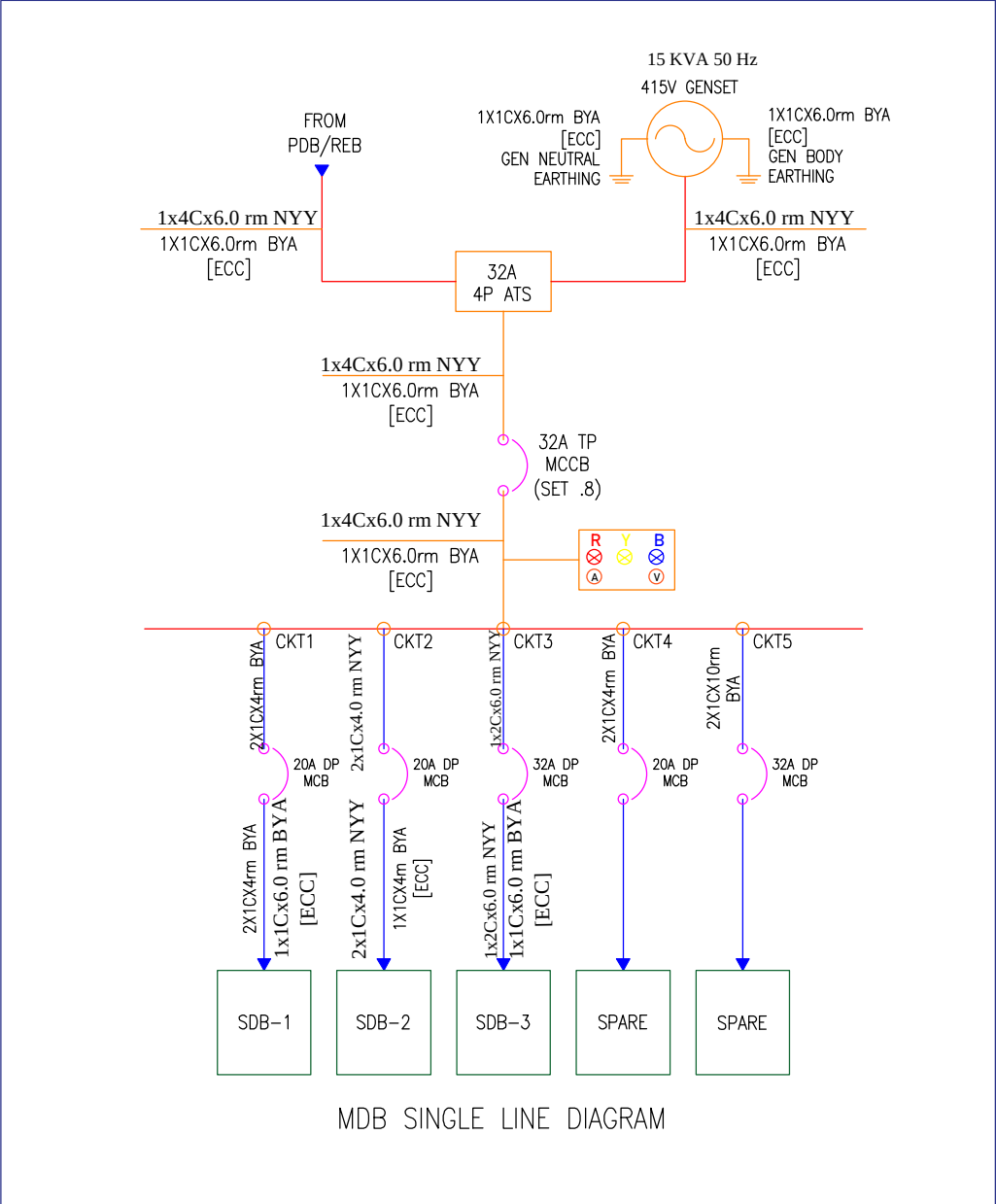

MDB SINGLE LINE DIAGRAM

CLIENT:	PROJECT NAME:	PARTICULARS:	NAME:	SIGNATURE:	DRAWING TITLE:	REVISION:	CONSULTANT:	-NOTES-	-COPYRIGHT-	REMARKS:	SHEET NO.:
UNHCR	ELECTRICAL DESIGN OF CAMP-1E NFIDISTRIBUTION POINT				MDB SLD	NO. DATE & TIME DESCRIPTION		THIS DRAWINGS SHALL BE READ IN CONJUNCTION WITH RELEVANT ARCHITECTURAL, PLUMBING, ELECTRICAL AND MECHANICAL DRAWINGS			E-05
PROJECT ADDRESS:	SCALE:				DATE:	01. - - -					
Camp-1E, UKHIYA, COX'S BAZAR	NOT IN SCALE				04-DEC-2025	02. - - -					
						03. - - -					
						04. - - -					
						05. - - -					

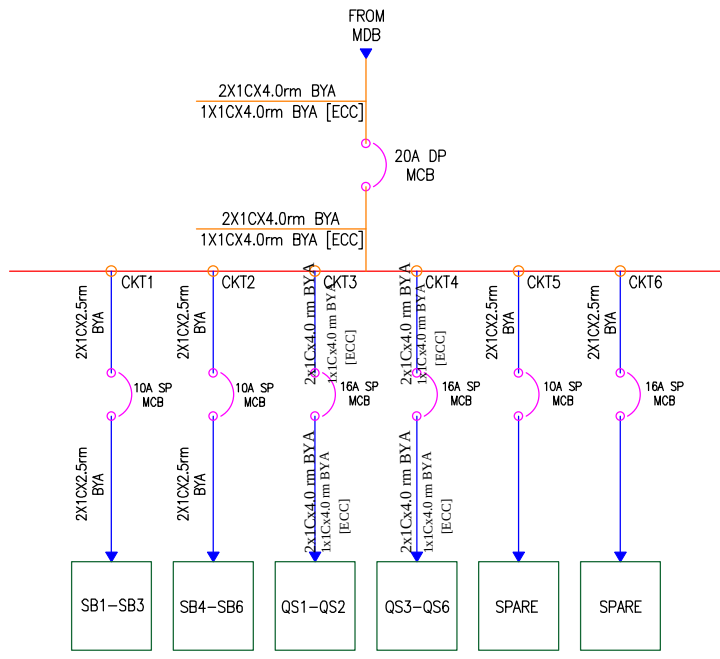

SDB-1 SINGLE LINE DIAGRAM

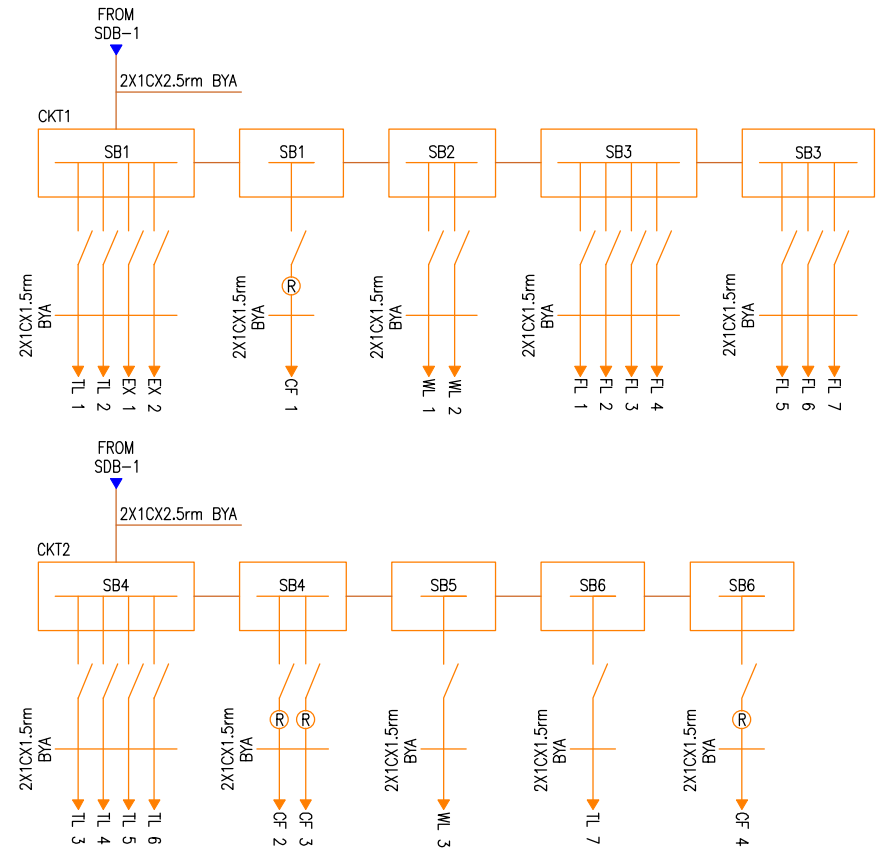

SDB-1 CIRCUIT DIAGRAM

CLIENT: UNHCR	PROJECT NAME: ELECTRICAL DESIGN OF CAMP-1E NFDISTRIBUTION POINT	PARTICULARS:	NAME:	SIGNATURE:	DRAWING TITLE: SDB-1 SLD & CIRCUIT DIAGRAM	REVISION NO. DATE & TIME: DESCRIPTION	CONSULTANT:	NOTES: THIS DRAWINGS SHALL BE READ IN CONJUNCTION WITH RELEVANT ARCHITECTURAL, PLUMBING, ELECTRICAL AND MECHANICAL DRAWINGS	COPYRIGHT:	REMARKS:	SHEET NO: E-06
PROJECT ADDRESS: Camp-1E, UKHIYA, COX'S BAZAR	SCALE: NOT IN SCALE				DATE: 04-DEC-2025	01. - - 02. - - 03. - - 04. - - 05. - -					

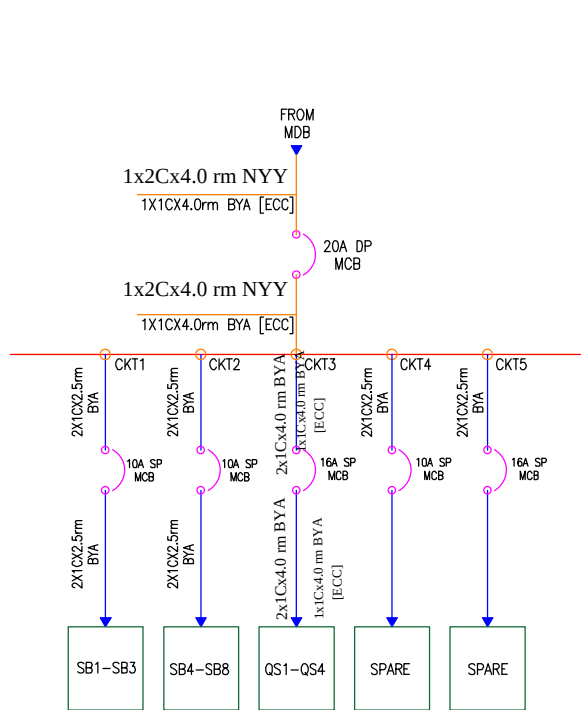

SDB-2 SINGLE LINE DIAGRAM

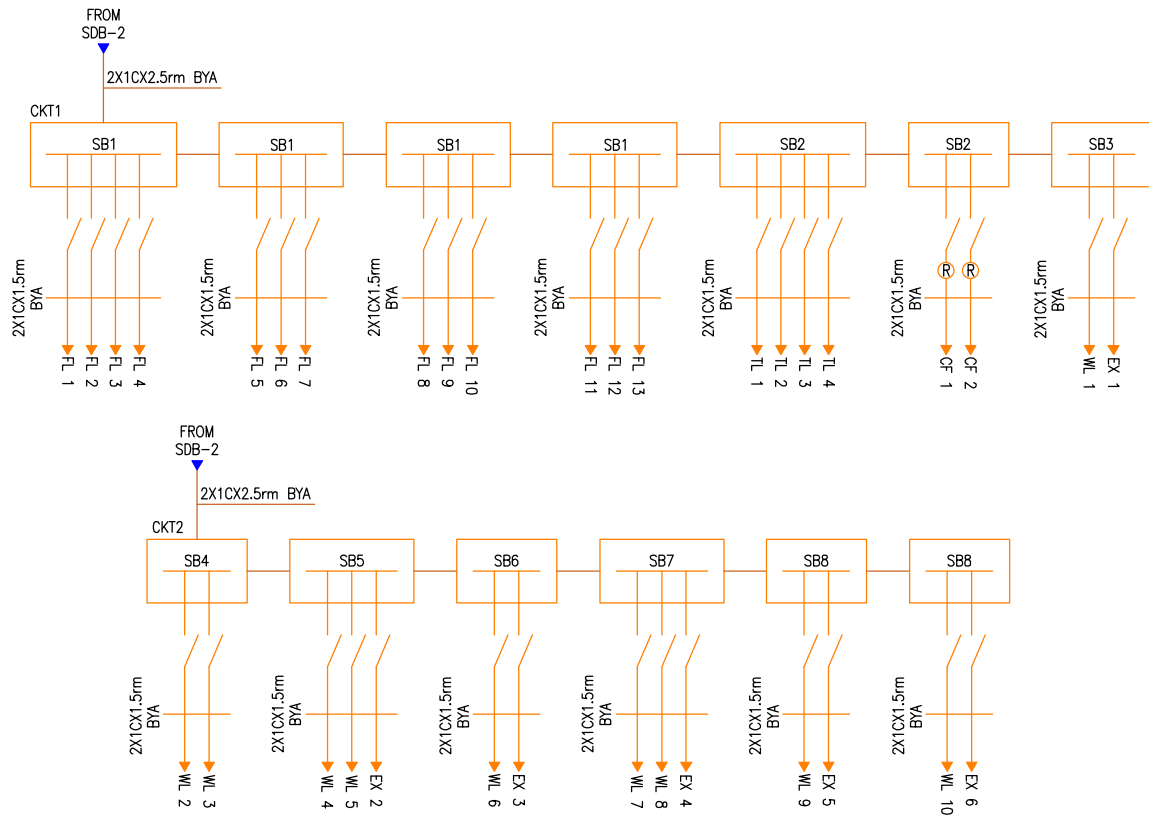

SDB-2 CIRCUIT DIAGRAM

CLIENT: UNHCR	PROJECT NAME: ELECTRICAL DESIGN OF CAMP-1E NF DISTRIBUTION POINT	PARTICULARS:	NAME:	SIGNATURE:	DRAWING TITLE: SDB-2 SLD & CIRCUIT DIAGRAM	REVISION:	CONSULTANT:	NOTES: THIS DRAWINGS SHALL BE READ IN CONJUNCTION WITH RELEVANT ARCHITECTURAL, PLUMBING, ELECTRICAL AND MECHANICAL DRAWINGS	COPYRIGHT:	REMARKS:	SHEET NO: E-07
PROJECT ADDRESS: Camp-1E, UKHIYA, COX'S BAZAR	SCALE: NOT IN SCALE				DATE: 04-DEC-2025	NO. DATE & TIME: DESCRIPTION					
						01. - -					
						02. - -					
						03. - -					
						04. - -					
						05. - -					

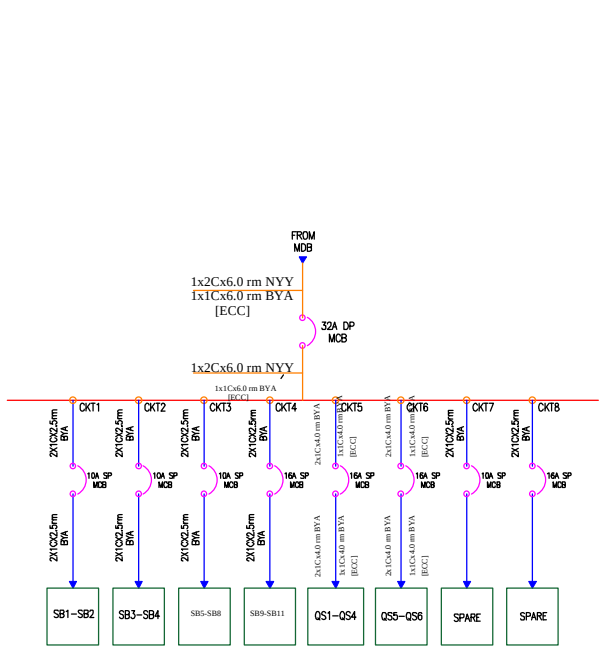

SDB-3 SINGLE LINE DIAGRAM

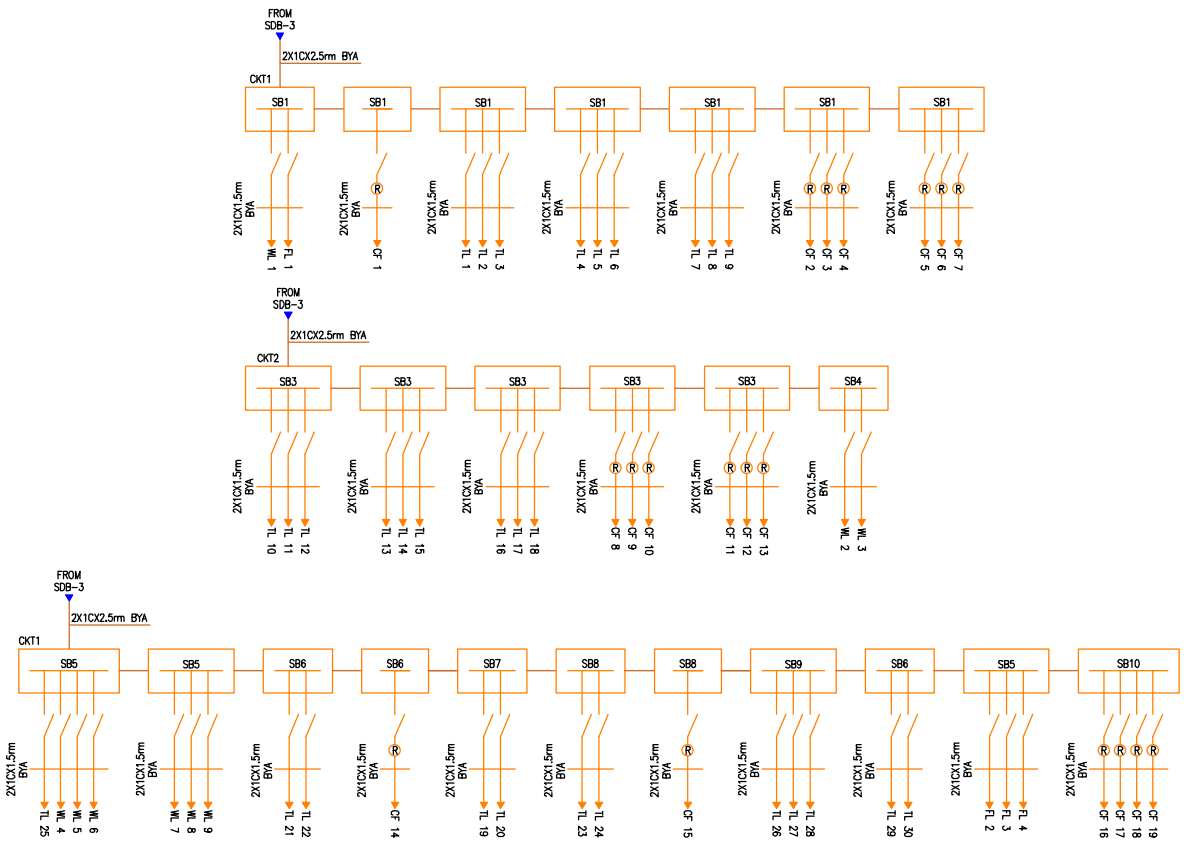

SDB-3 CIRCUIT DIAGRAM

CLIENT : UNHCR	PROJECT NAME: ELECTRICAL DESIGN OF CAMP-1E NFIDISTRIBUTION POINT	PARTICULARS	NAME :	SIGNATURE:	DRAWING TITLE: SDB-3 SLD & CIRCUIT DIAGRAM	REVISION	CONSULTANT:	NOTES: THIS DRAWINGS SHALL BE READ IN CONJUNCTION WITH RELEVANT ARCHITECTURAL, PLUMBING, ELECTRICAL AND MECHANICAL DRAWINGS	COPYRIGHT:	REMARKS	SHEET NO: E-08
PROJECT ADDRESS : Camp-1E, UKHIYA, COX'S BAZAR	SCALE: NOT IN SCALE				DATE: 04-DEC-2025	NO. DATE & TIME: DESCRIPTION					
						01. - -					
						02. - -					
						03. - -					
						04. - -					
						05. - -					

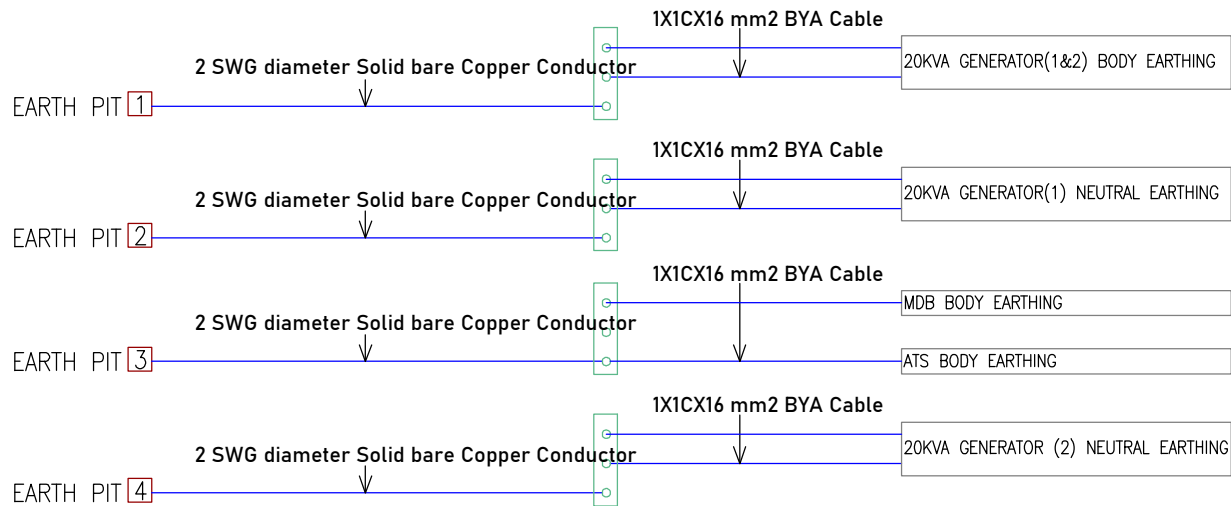
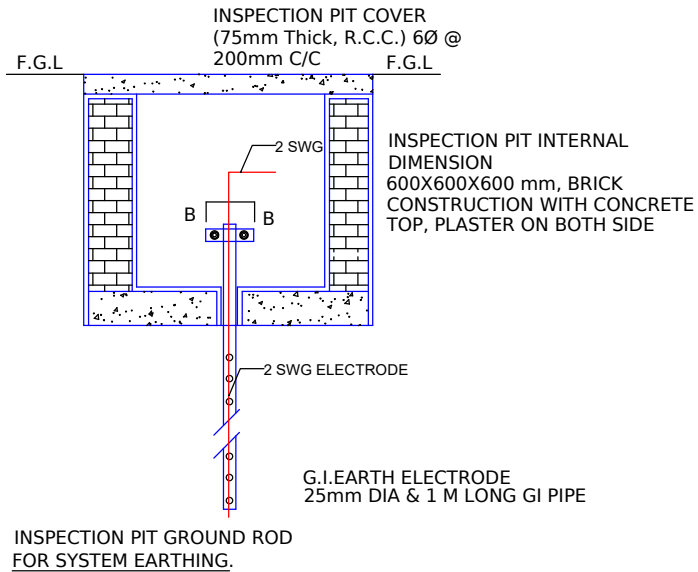

Earthing Layout Drawing

CLIENT: UNHCR	PROJECT NAME: ELECTRICAL DESIGN OF CAMP-1E NEFDISTRIBUTION POINT	PARTICULARS:	NAME:	SIGNATURE:	DRAWING TITLE: EARTHING DETAILS	REVISION NO. DATE & TIME DESCRIPTION	CONSULTANT:	NOTES: THIS DRAWINGS SHALL BE READ IN CONJUNCTION WITH RELEVANT ARCHITECTURAL, PLUMBING, ELECTRICAL AND MECHANICAL DRAWINGS	COPYRIGHT:	REMARKS:	SHEET NO: E-09
PROJECT ADDRESS: Camp-1E, UKHIYA, COX'S BAZAR	SCALE: NOT IN SCALE				DATE: 04-DEC-2025	01. - - 02. - - 03. - - 04. - - 05. - -					

**PROJECT: ELECTRICAL DESIGN OF CAMP-1E NFI
DISTRIBUTION POINT**

Location: Camp-1E, Ukhiya, Cox's Bazar.

Date of Submission: December 04, 2025

Drawing Title: LPS DRAWING

RISK INDEX ASSESSMENT AS PER BNBC 2006

INDEX	TITLE	DETAILS	POINTS
A	USE OF STRUCTURE	Office block	7
B	TYPE OF CONTRUCTION	Metal Roof	5
C	CONTENTS OR CONSEQUENTIAL EFFECTS	Not containing valuable materials	2
D	DEGREE OF ISOLATION	Structure located in a large area having structures or trees of similar or greater height, e.g. a large town or forest	2
E	TYPE OF TERRAIN	Hilly terrain	6
F	HIGHT OF STRUCTURE	Up to 9 m	2
G	LIGHTNING PREVALENCE	Over 21	21
	THE SUM OF INDEX		45
	MARGINAL RISK INDEX		40
	REMARKS	LIGHTNING PROTECTION IS REQUIRED	

CLIENT: UNHCR	PROJECT NAME: ELECTRICAL DESIGN OF CAMP-1E NFIDISTRIBUTION POINT	PARTICULARS:	NAME:	SIGNATURE:	DRAWING TITLE: RISK INDEX	REVISION	CONSULTANT:	- NOTES -	-COPYRIGHT-	REMARKS	SHEET NO: LPS-01																		
PROJECT ADDRESS: Camp-1E, UKHIYA, COX'S BAZAR	SCALE: NOT IN SCALE				DATE: 04-DEC-2025	<table border="1" style="width: 100%; border-collapse: collapse;"> <thead> <tr> <th>NO.</th> <th>DATE & TIME</th> <th>DESCRIPTION</th> </tr> </thead> <tbody> <tr><td>01.</td><td>-</td><td>-</td></tr> <tr><td>02.</td><td>-</td><td>-</td></tr> <tr><td>03.</td><td>-</td><td>-</td></tr> <tr><td>04.</td><td>-</td><td>-</td></tr> <tr><td>05.</td><td>-</td><td>-</td></tr> </tbody> </table>	NO.	DATE & TIME	DESCRIPTION	01.	-	-	02.	-	-	03.	-	-	04.	-	-	05.	-	-		THIS DRAWINGS SHALL BE READ IN CONJUNCTION WITH RELEVANT ARCHITECTURAL, PLUMBING, ELECTRICAL AND MECHANICAL DRAWINGS			
NO.	DATE & TIME	DESCRIPTION																											
01.	-	-																											
02.	-	-																											
03.	-	-																											
04.	-	-																											
05.	-	-																											

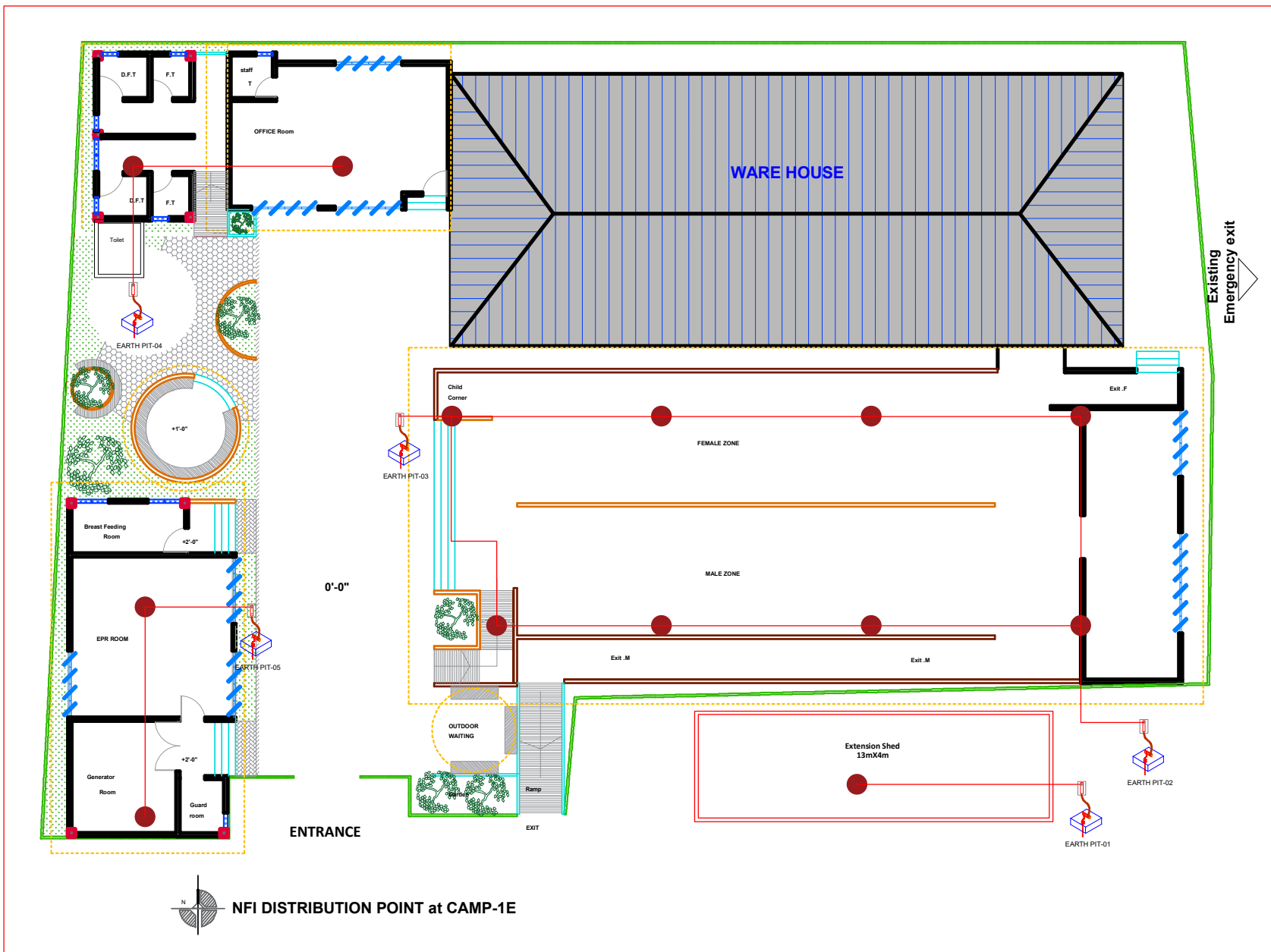

CLIENT: UNHCR	PROJECT NAME: ELECTRICAL DESIGN OF CAMP-1E NFI DISTRIBUTION POINT	PARTICULARS:	NAME:	SIGNATURE:	DRAWING TITLE: LPS LAYOUT	REVISION NO. DATE & TIME: DESCRIPTION	CONSULTANT:	NOTES: THIS DRAWINGS SHALL BE READ IN CONJUNCTION WITH RELEVANT ARCHITECTURAL, PLUMBING, ELECTRICAL AND MECHANICAL DRAWINGS	COPYRIGHT:	REMARKS:	SHEET NO: LPS-02
PROJECT ADDRESS: Camp-1E, UKHIYA, COX'S BAZAR	SCALE: NOT IN SCALE				DATE: 04-DEC-2025	01. - 02. - 03. - 04. - 05. -					

DESIGN STANDARD : NFPA 780, EDITION 2014

LEGEND	
Symbol	Explanation
	Air Terminal
	Roof & Down Conductor
	Grounding Electrode

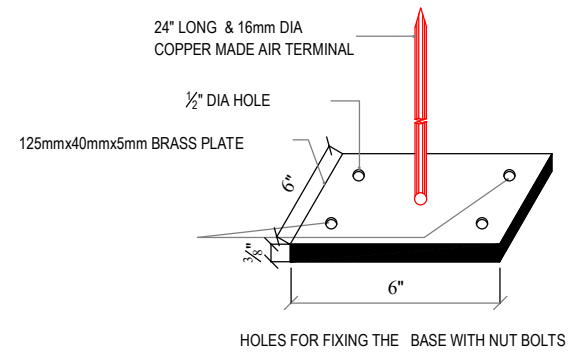
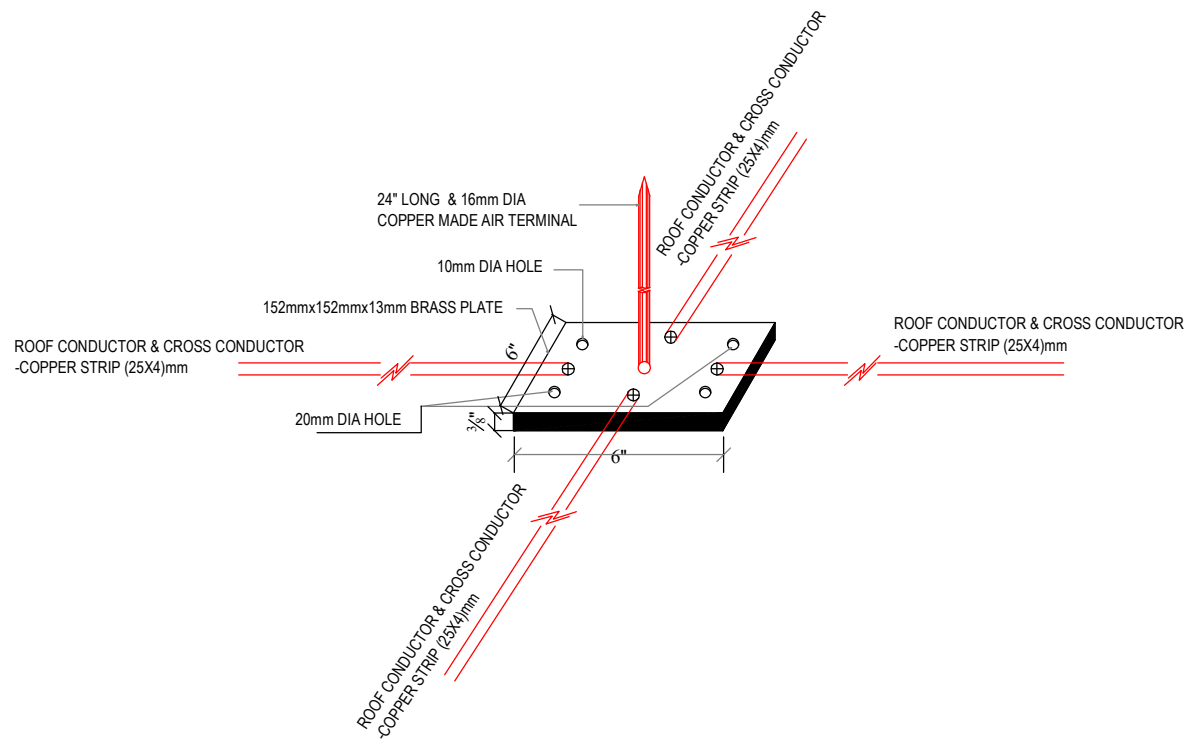
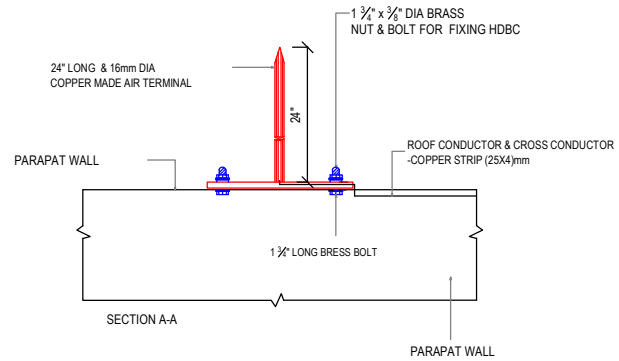

CLIENT UNHCR	PROJECT NAME ELECTRICAL DESIGN OF CAMP-1E NFIDISTRIBUTION POINT	PARTICULARS	NAME	SIGNATURE	DRAWING TITLE AIR TERMINAL DETAILS	REVISION	CONSULTANT	NOTES THIS DRAWINGS SHALL BE READ IN CONJUNCTION WITH RELEVANT ARCHITECTURAL, PLUMBING, ELECTRICAL AND MECHANICAL DRAWINGS	COPYRIGHT	REMARKS	SHEET NO. LPS-03
PROJECT ADDRESS Camp-1E, UKHIYA, COX'S BAZAR	SCALE NOT IN SCALE				DATE 04-DEC-2025	NO. DATE & TIME DESCRIPTION 01. - - - 02. - - - 03. - - - 04. - - - 05. - - -					

DESIGN STANDARD : NFPA 780, EDITION 2014

LEGEND	
Symbol	Explanation
	Air Terminal
	Roof & Down Conductor
	Grounding Electrode

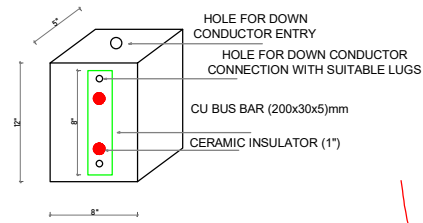

EARTH RESISTANCE TEST POINT

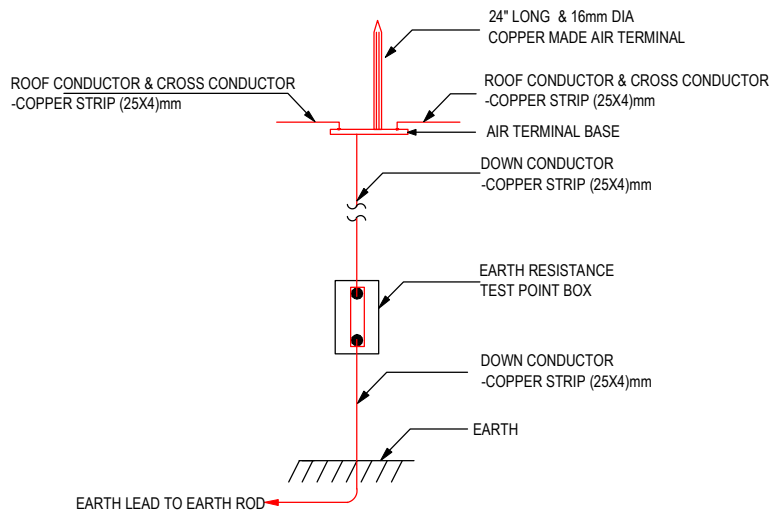
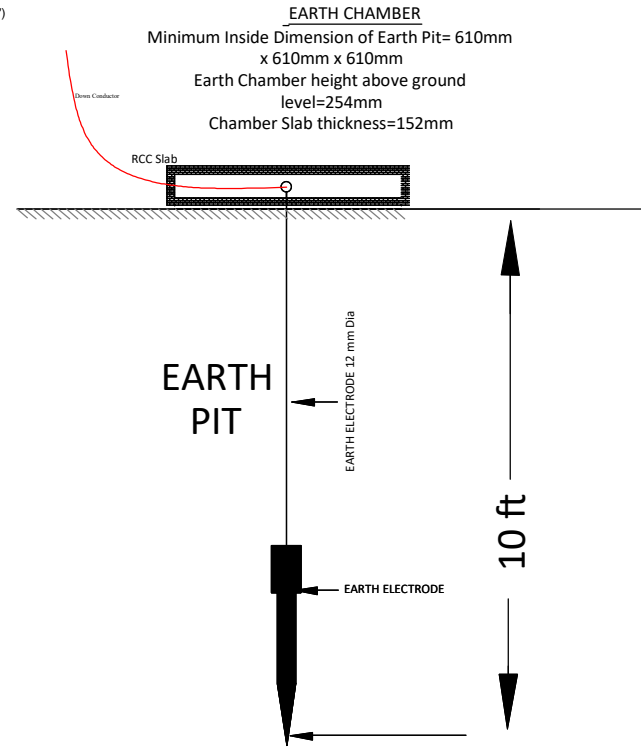

CLIENT: UNHCR	PROJECT NAME: ELECTRICAL DESIGN OF CAMP-1E REDISTRIBUTION POINT	PARTICULARS	NAME:	SIGNATURE:	DRAWING TITLE: LPS EARTHING DETAILS	REVISION	CONSULTANT:	-NOTES- THIS DRAWINGS SHALL BE READ IN CONJUNCTION WITH RELEVANT ARCHITECTURAL, PLUMBING, ELECTRICAL AND MECHANICAL DRAWINGS	COPYRIGHT:	REMARKS	SHEET NO: LPS-04
PROJECT ADDRESS: Camp-1E, UKHIYA, COX'S BAZAR	SCALE: NOT IN SCALE				DATE: 04-DEC-2025	NO. DATE & TIME DESCRIPTION 01. - - - 02. - - - 03. - - - 04. - - - 05. - - -					

PROJECT:

**ELECTRICAL DESIGN OF CAMP-1E NFI
DISTRIBUTION POINT**

Location:

Camp-1E, Ukhiya, Cox's Bazar.

Date of Submission:



December 04, 2025

Drawing Title:

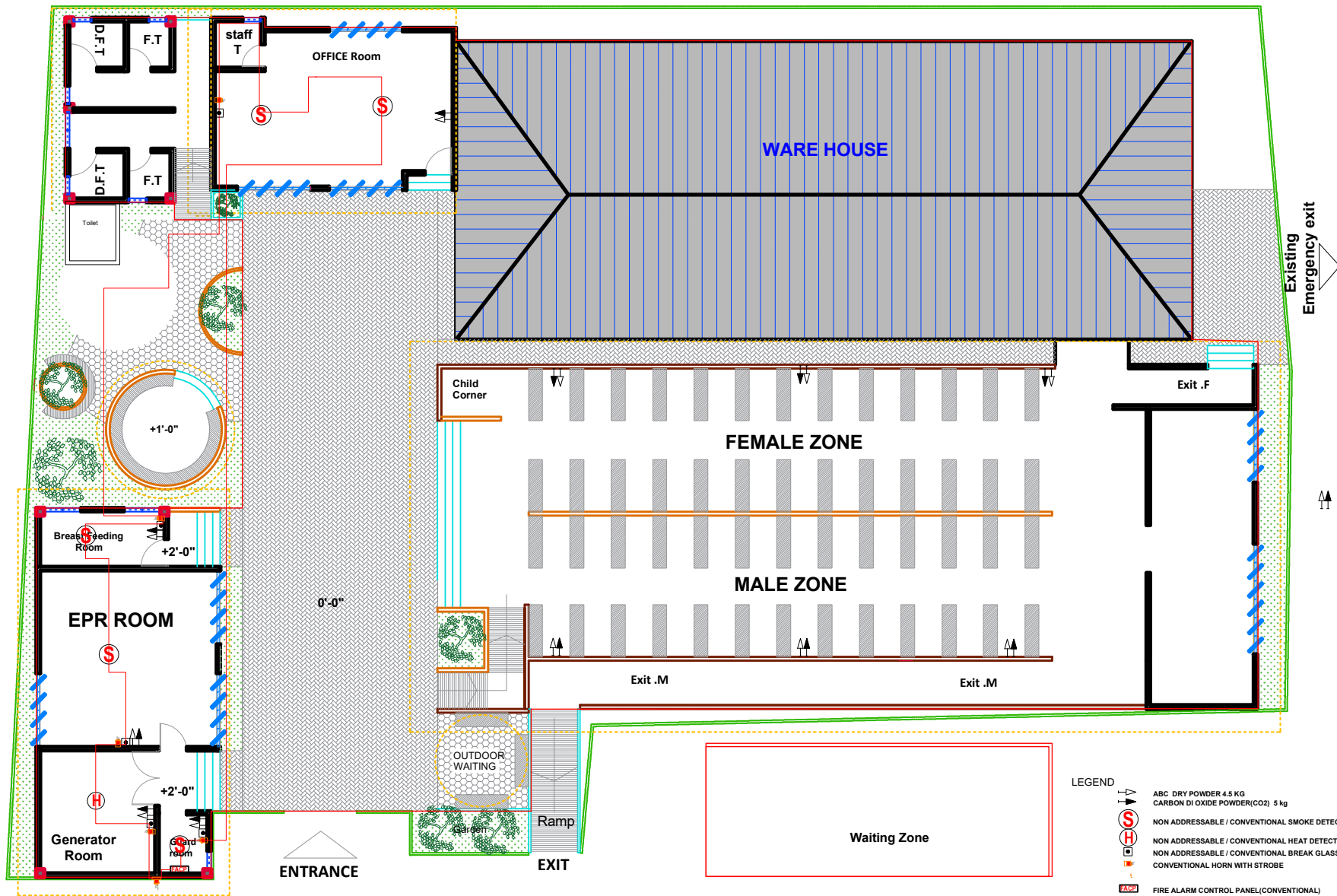
FIRE DRAWING



**NFI DISTRIBUTION POINT
at CAMP-1E**

- LEGEND**
-  ABC DRY POWDER 4.5 KG
 -  CARBON DI OXIDE POWDER(CO2) 5 kg
 -  NON ADDRESSABLE / CONVENTIONAL SMOKE DETECTOR
 -  NON ADDRESSABLE / CONVENTIONAL HEAT DETECTOR
 -  NON ADDRESSABLE / CONVENTIONAL BREAK GLASS
 -  CONVENTIONAL HORN WITH STROBE
 -  FIRE ALARM CONTROL PANEL(CONVENTIONAL)
 -  FIRE WIRE

CLIENT:	PROJECT NAME:	PARTICULARS:	NAME:	SIGNATURE:	DRAWING TITLE:	REVISION:	CONSULTANT:	NOTES:	COPYRIGHT:	REMARKS:	SHEET NO.:																			
UNHCR	ELECTRICAL DESIGN OF CAMP-1E NFI DISTRIBUTION POINT				FIRE DESIGN	<table border="1" style="width: 100%; border-collapse: collapse;"> <thead> <tr> <th>NO.</th> <th>DATE & TIME:</th> <th>DESCRIPTION</th> </tr> </thead> <tbody> <tr><td>01.</td><td>-</td><td>-</td></tr> <tr><td>02.</td><td>-</td><td>-</td></tr> <tr><td>03.</td><td>-</td><td>-</td></tr> <tr><td>04.</td><td>-</td><td>-</td></tr> <tr><td>05.</td><td>-</td><td>-</td></tr> </tbody> </table>	NO.	DATE & TIME:	DESCRIPTION	01.	-	-	02.	-	-	03.	-	-	04.	-	-	05.	-	-		THIS DRAWINGS SHALL BE READ IN CONJUNCTION WITH RELEVANT ARCHITECTURAL, PLUMBING, ELECTRICAL AND MECHANICAL DRAWINGS				
NO.	DATE & TIME:	DESCRIPTION																												
01.	-	-																												
02.	-	-																												
03.	-	-																												
04.	-	-																												
05.	-	-																												
PROJECT ADDRESS:	SCALE:				DATE:																									
Camp-1E, UKHYIA, COX'S BAZAR	NOT IN SCALE				04-DEC-2025						F-01																			